

Products > Aperture Wafers > A22.00

# Aperture Wafers - A22.00

## Specifications

<b>Model</b>	A22.00
<b>Inside Diameter</b>	.0030/.00315"
<b>Outside Diameter</b>	.114/.122"
<b>Thickness</b>	.024/.026"
<b>Radius</b>	.025/.030"
<b>ID Length</b>	.0026/.0030"



**Description**

Aperture Wafers are precision controlled orifices where the ID Length is controlled very tightly.

---

**Typical Applications**

- Hematology Instrumentation
- Ink Jet Printing
- Flow Control

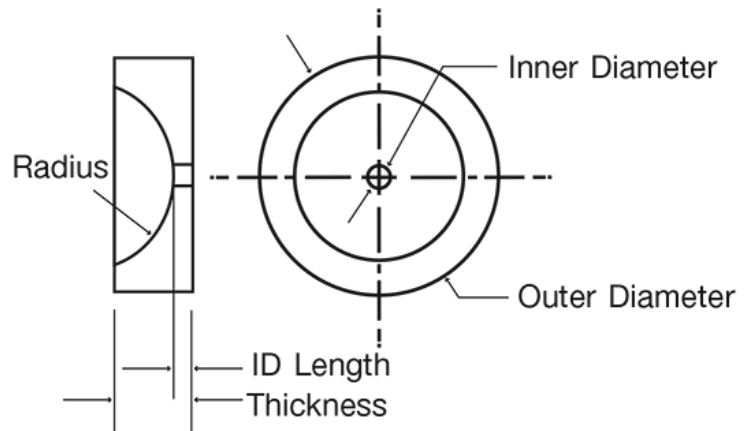

### NOT SEEING EXACTLY WHAT YOU NEED?

We specialize in creating a wide range of custom optical components and custom mechanical components including a variety of shapes - from internal holes and tapers to outer flanges, angles and surface finishes. Contact us and we will consult with you to create a custom component that meets all of your specifications.